

Mélykút CAN – 2022. augusztus 12-14.

MARATON IDŐTÁBLA			CAN-A				
Akadályok: 1234567	hossz (m)	jármód	iram km/h	Minimum idő	Alap idő	Maximum idő	Kötelező kapu
Kontrolált bemelegítés előtt 10 perccel állatorvosi kontroll							
Kontrolált bemelegítés		free		00:28:00	00:30:00	00:36:00	
Nautral zone	550				00:06:00		
Halt					00:05:00		
Bemelegató akadály					00:02:00		
B szakasz	7.560	Acc. To rules	14	00:29:24	00:32:24	01:04:48	

Mélykút CAN – 2022. augusztus 12-14.

MARATON IDŐTÁBLA			CAN-B				
Akadályok: _234567	hossz (m)	jármód	iram km/h	Minimum idő	Alap idő	Maximum idő	Kötelező kapu
Kontrolált bemelegítés előtt 10 perccel állatorvosi kontroll							
Kontrolált bemelegítés		free		00:28:00	00:30:00	00:36:00	
Nautral zone	550				00:06:00		
Halt					00:05:00		
Bemelegató akadály					00:02:00		
B szakasz	6.380	Acc. To rules	13	00:26:27	00:29:27	00:58:54	

Mélykut 2022 Maraton

B Szakasz CAN-A H1 H2 H4

7560 Fehér km tábla

B start

1 kötelező kapu

1 akadály

1 km

2 kötelező kapu

2 akadály

2 km

3 kötelező kapu

3 akadály 3 km

4 kötelező kapu

4 akadály 4 km

5 kötelező kapu

5 akadály 5 km

6 kötelező kapu

6 akadály 6km

7 kötelező kapu

8 kötelező kapu

7 km

7 akadály

B cél

Mélykut 2022 Maraton

B Szakasz CAN-B H1 H2

6380 Sárga km tábla

B start

1 kötelező kapu

2 akadály 1 km

2 kötelező kapu

3 akadály 2 km

3 kötelező kapu

4 akadály 3 km

4 kötelező kapu

5 akadály

4 km

5 kötelező kapu

6 akadály

6 kötelező kapu

5 km

7 kötelező kapu

7 akadály 6 km

B cél

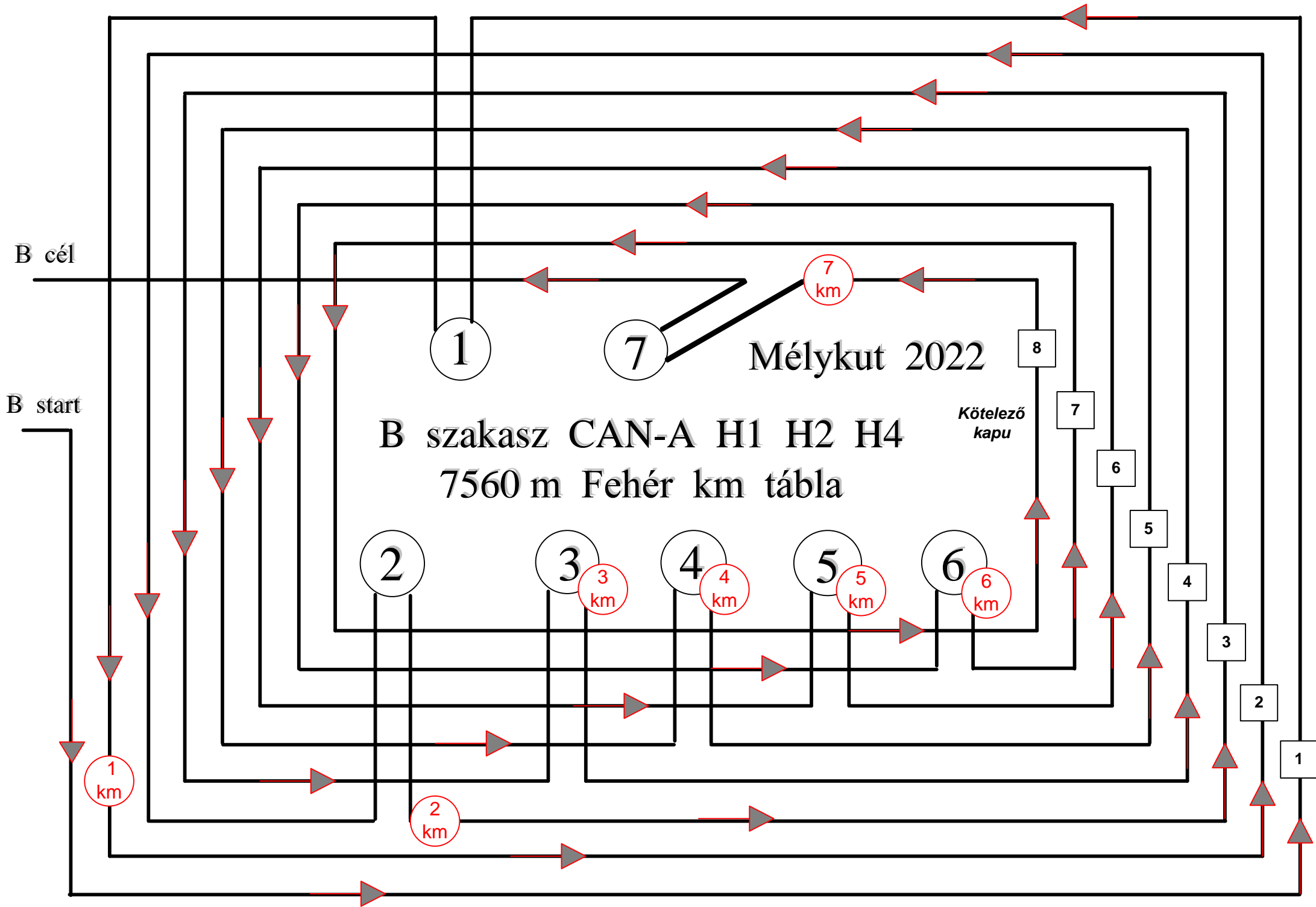

B cél

B start

B szakasz CAN-B H1 H2
6380 m Sárga km tábla

Mélykut 2022

Kötelező kapu

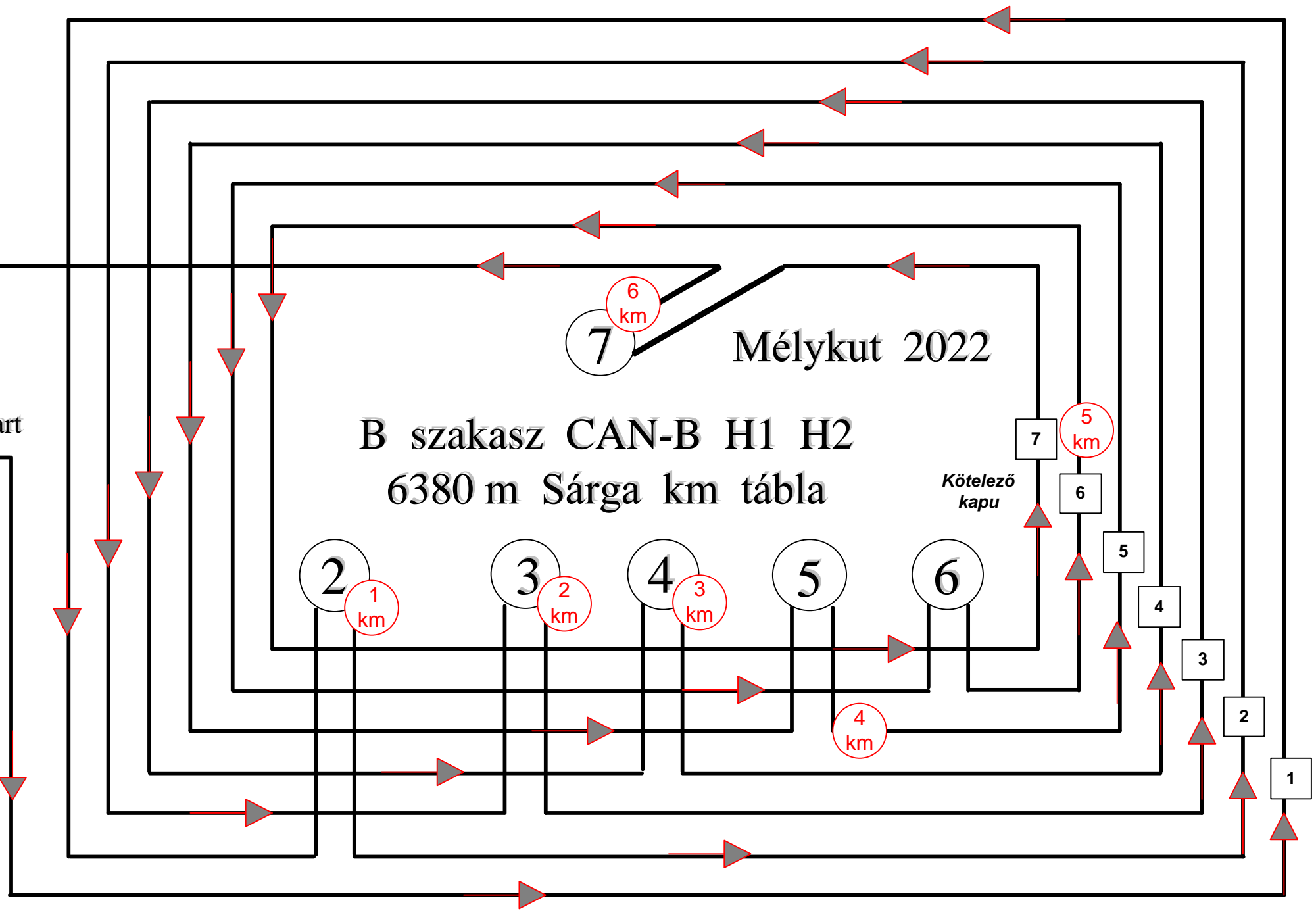

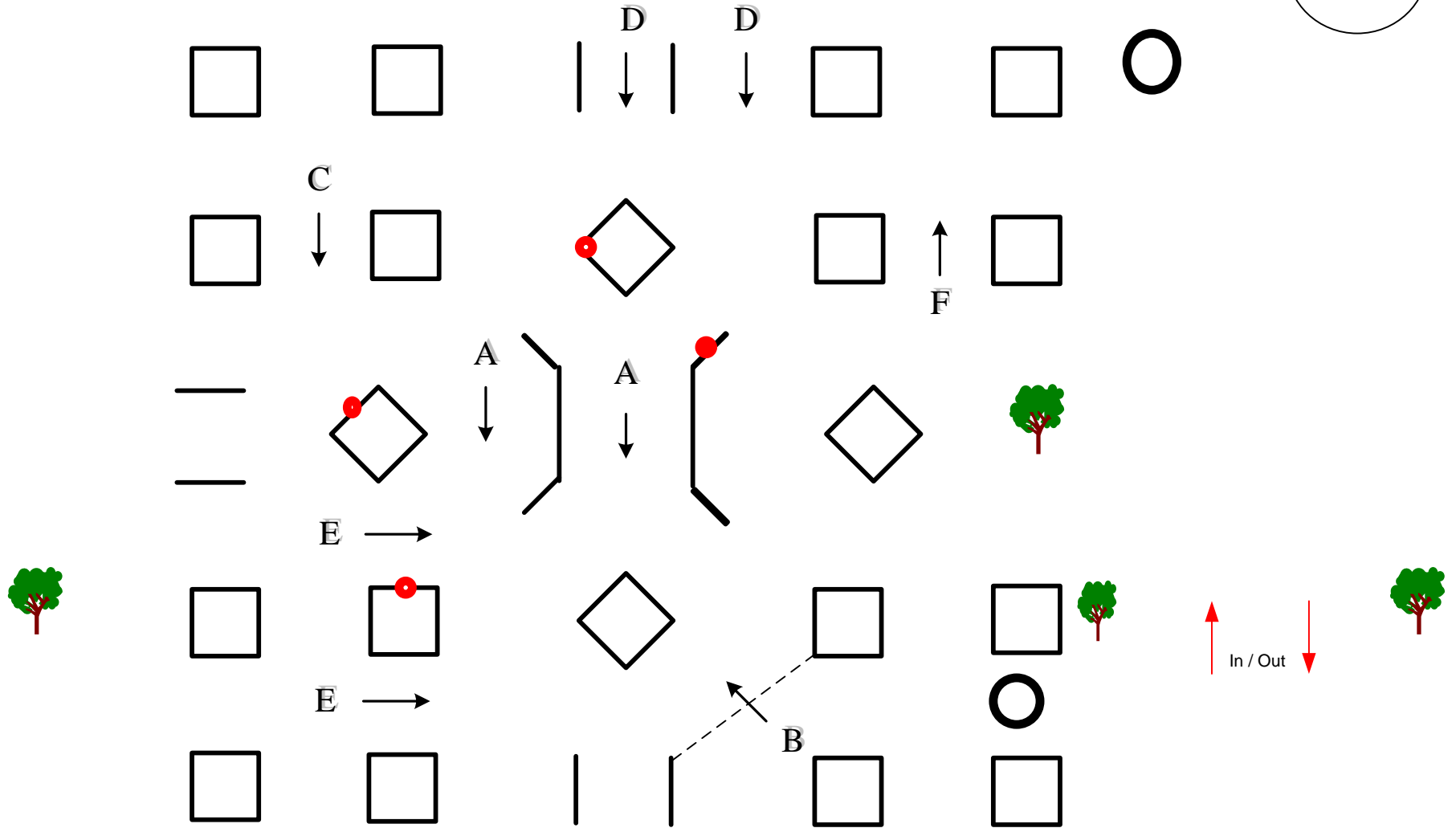

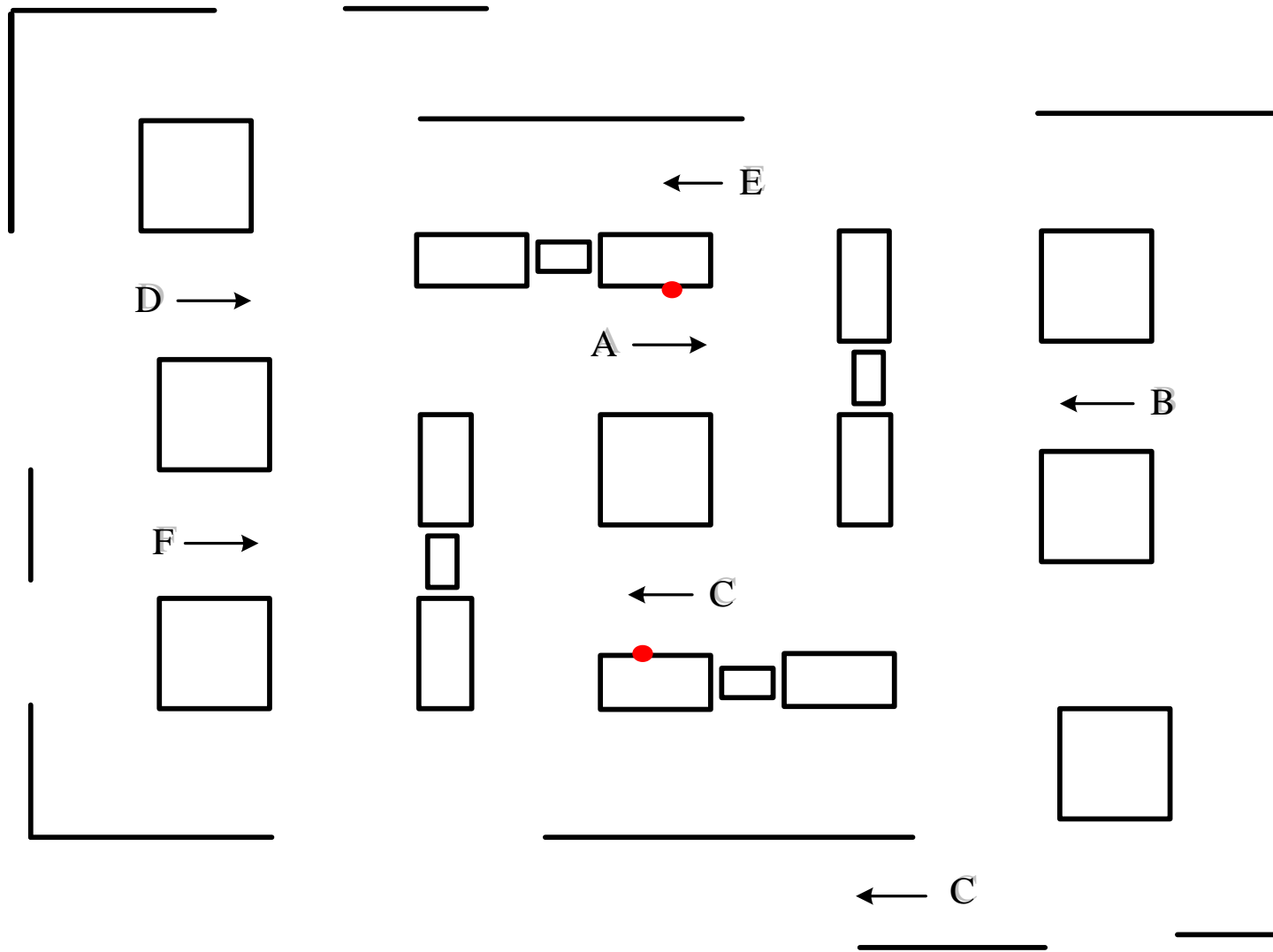

CAN-A H1- H2- H4 : A-B-C-D-E-F

CAN-B H1- H2 : A-B-C-D-E

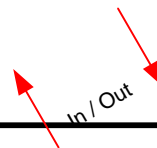

Verhető elem: 2 db

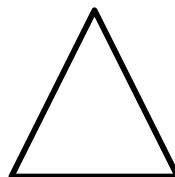
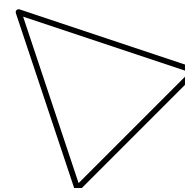
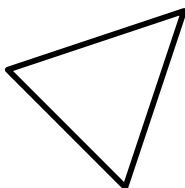
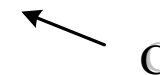
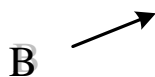
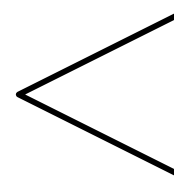
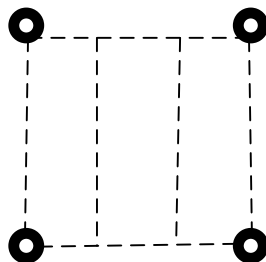
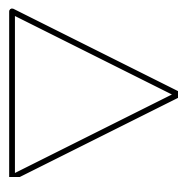
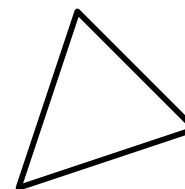
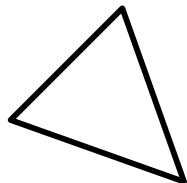
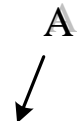
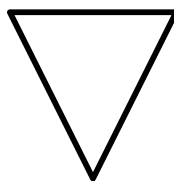
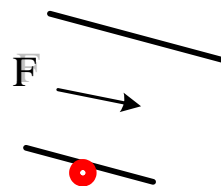
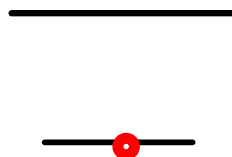
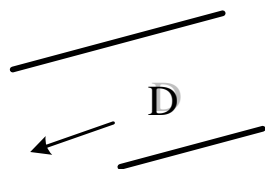

CAN-A H1- H2- H4 : A-B-C-D-E-F

CAN-B H1- H2 : A-B-C-D-E

Verhető elem: 2 db

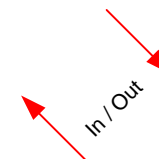

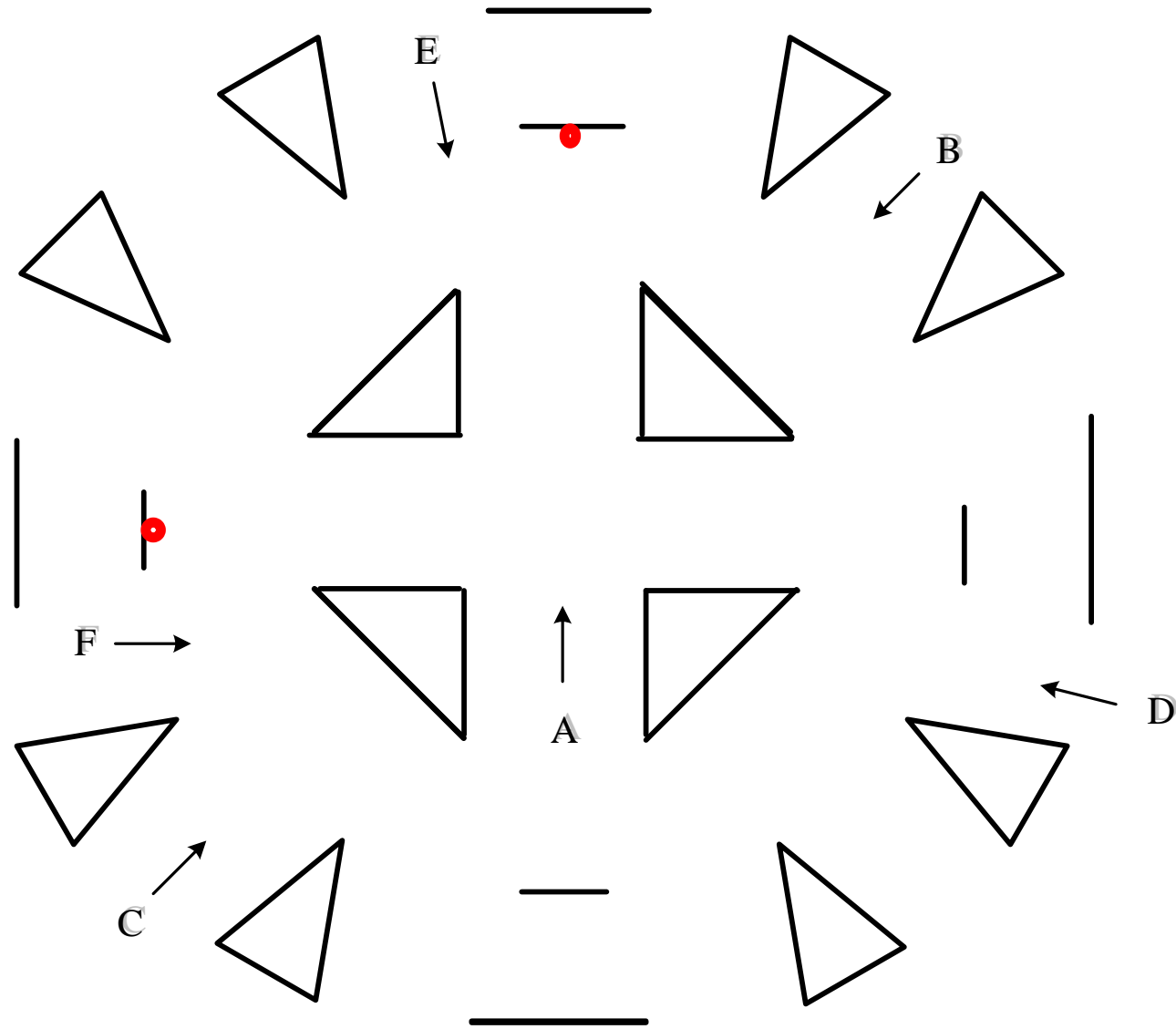

CAN-A H1- H2- H4 : A-B-C-D-E-F

CAN-B H1- H2 : A-B-C-D-E

Verhető elem: 2 db

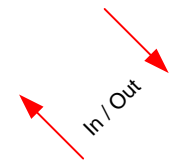

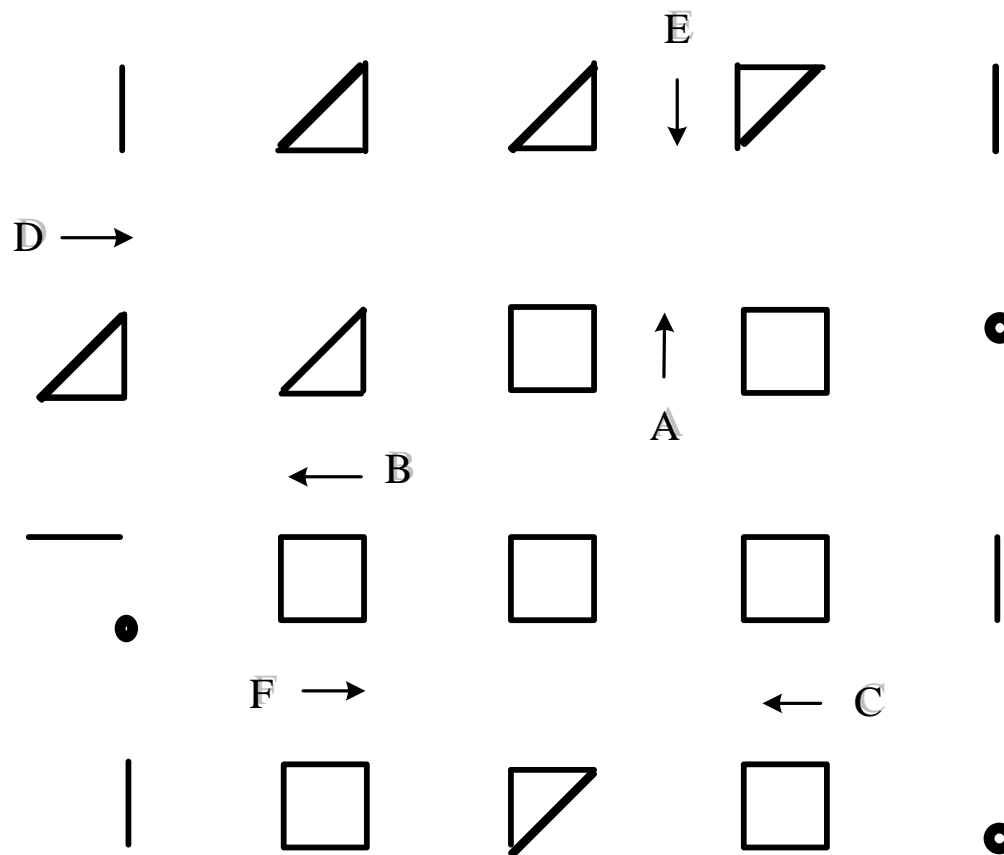

CAN-A H1- H2- H4 : A-B-C-D-E-F

CAN-B H1- H2 : A-B-C-D-E

Verhető elem: 0 db

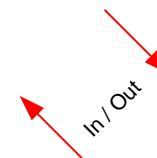

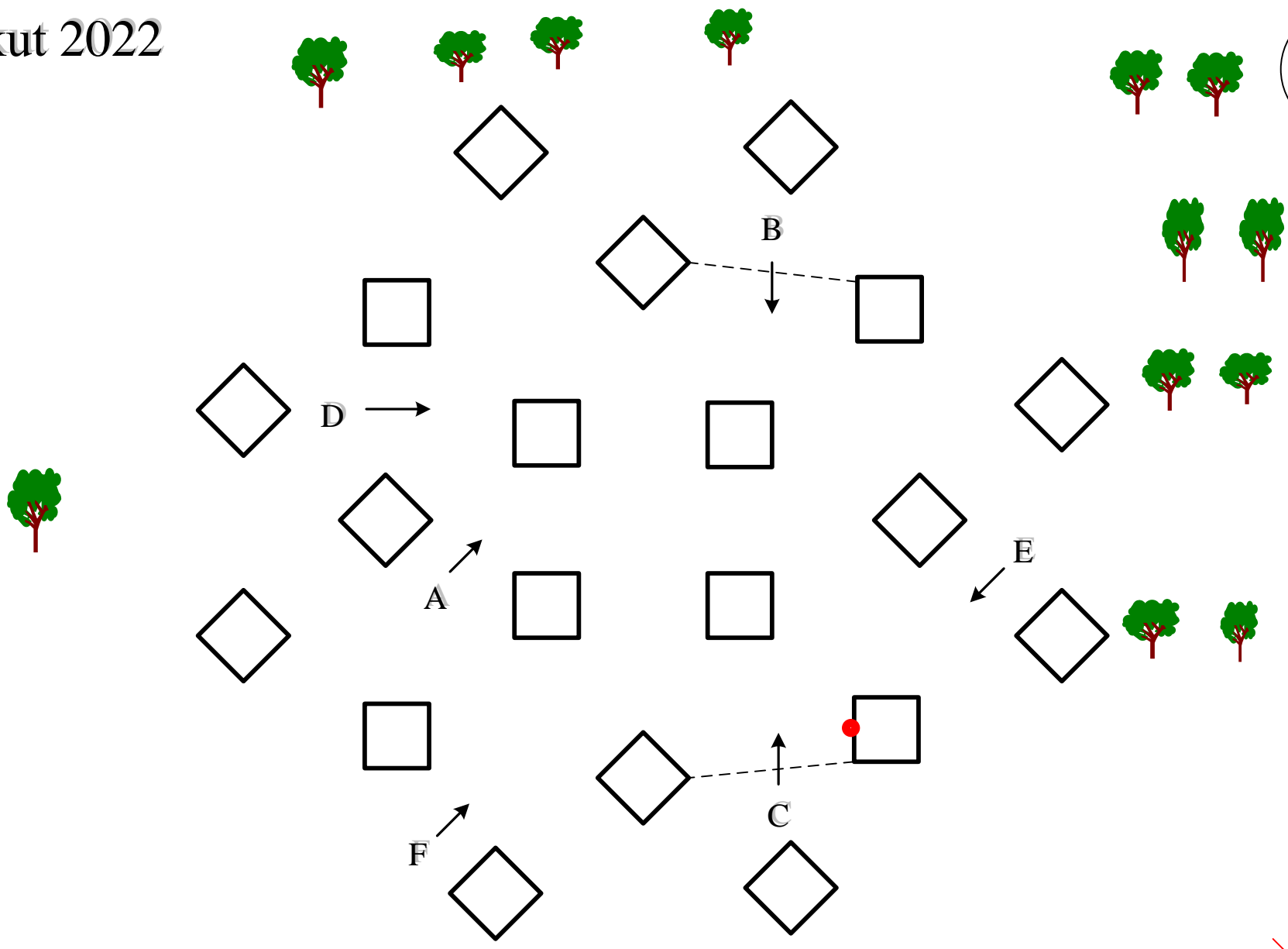

CAN-A H1- H2- H4 : A-B-C-D-E-F

CAN-B H1- H2 : A-B-C-D-E

Verhető elem: 1 db

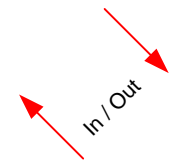

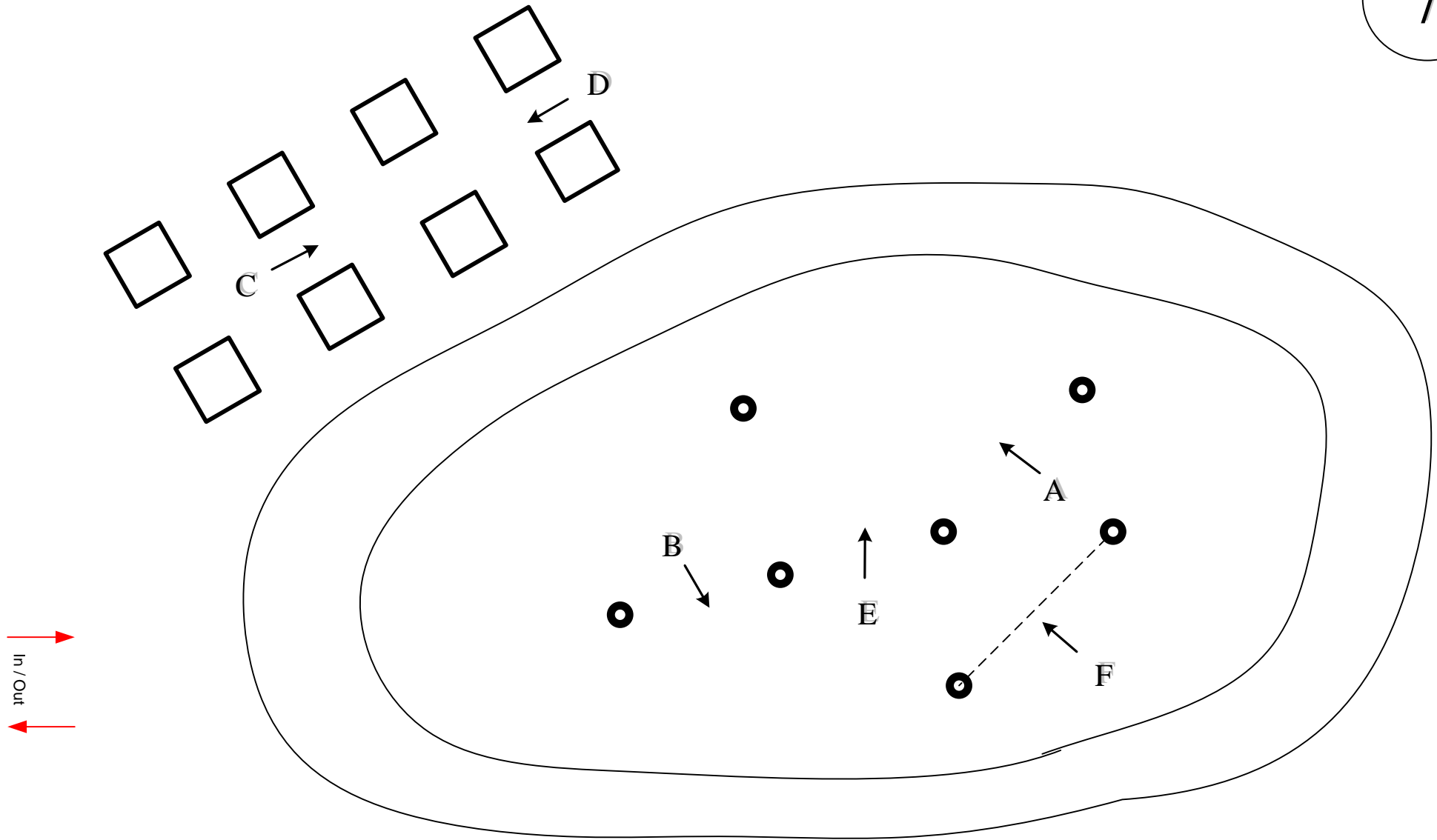

CAN-A H1- H2- H4 : A-B-C-D-E-F

CAN-B H1- H2 : A-B-C-D-E

Verhető elem: 0 db