

CAI3*/2*, CAN Vecsés (HUN) 1 - 5 June 2022

MARATHON TIMETABLE			CAI3*-H1, H2, H4, CAN-A H2				
Obstacles:1234567 Gates: A-F	length (m)	pace	speed in km/h	Minimum time	Time allowed	Time Limit	Obligatory gates
10 min before Warm Up: Horse Inspection in Harness							
Warm Up				00:28:00	00:30:00	00:36:00	
Halt					00:05:00		
Training Obstacle					00:02:00		
Section B	7.330	Acc. To rules	13	00:30:50	00:33:55	01:07:40	8
Cool Down				00:10:00	00:15:00		

CAI3*/2*, CAN Vecsés (HUN) 1 - 5 June 2022

MARATHON TIMETABLE			CAI2*-H1, H2, H4, CAN-B, PARA, U25-H1				
Obstacles:_234567 Gates: A-E	length (m)	pace	speed in km/h	Minimum time	Time allowed	Time Limit	Obligatory gates
10 min before Warm Up: Horse Inspection in Harness							
Warm Up				00:28:00	00:30:00	00:36:00	
Halt					00:05:00		
Training Obstacle					00:02:00		
Section B	6.690	Acc. To rules	13	00:27:53	00:30:53	01:01:46	8
Cool Down				00:10:00	00:15:00		

CAI3*/2*, CAN Vecsés (HUN) 1 - 5 June 2022

MARATHON TIMETABLE			Junior P1, P2, U25-P2				
Obstacles:_234567 Gates: A-E	length (m)	pace	speed in km/h	Minimum time	Time allowed	Time Limit	Obligatory gates
10 min before Warm Up: Horse Inspection in Harness							
Warm Up				00:28:00	00:30:00	00:36:00	
Halt					00:05:00		
Training Obstacle					00:02:00		
Section B	6.690	Acc. To rules	12	00:30:27	00:33:27	01:06:54	8
Cool Down				00:10:00	00:15:00		

CAI3*/2*, CAN Vecsés (HUN) 1 - 5 June 2022

MARATHON TIMETABLE			Gyermek				
Obstacles: 12345 Gates: A-D	length (m)	pace	speed in km/h	Minimum time	Time allowed	Time Limit	Obligatory gates
10 min before Warm Up: Horse Inspection in Harness							
Warm Up				00:28:00	00:30:00	00:36:00	
Halt					00:05:00		
Training Obstacle					00:02:00		
Section B	4.990	Acc. To rules	12	00:21:57	00:24:57	00:49:54	6
Cool Down				00:10:00	00:15:00		



CAI* H4**
CAN A H2

VECSÉS 2022
MARATON COMPETITION
PHASE B

7330 m

CTF

CTF

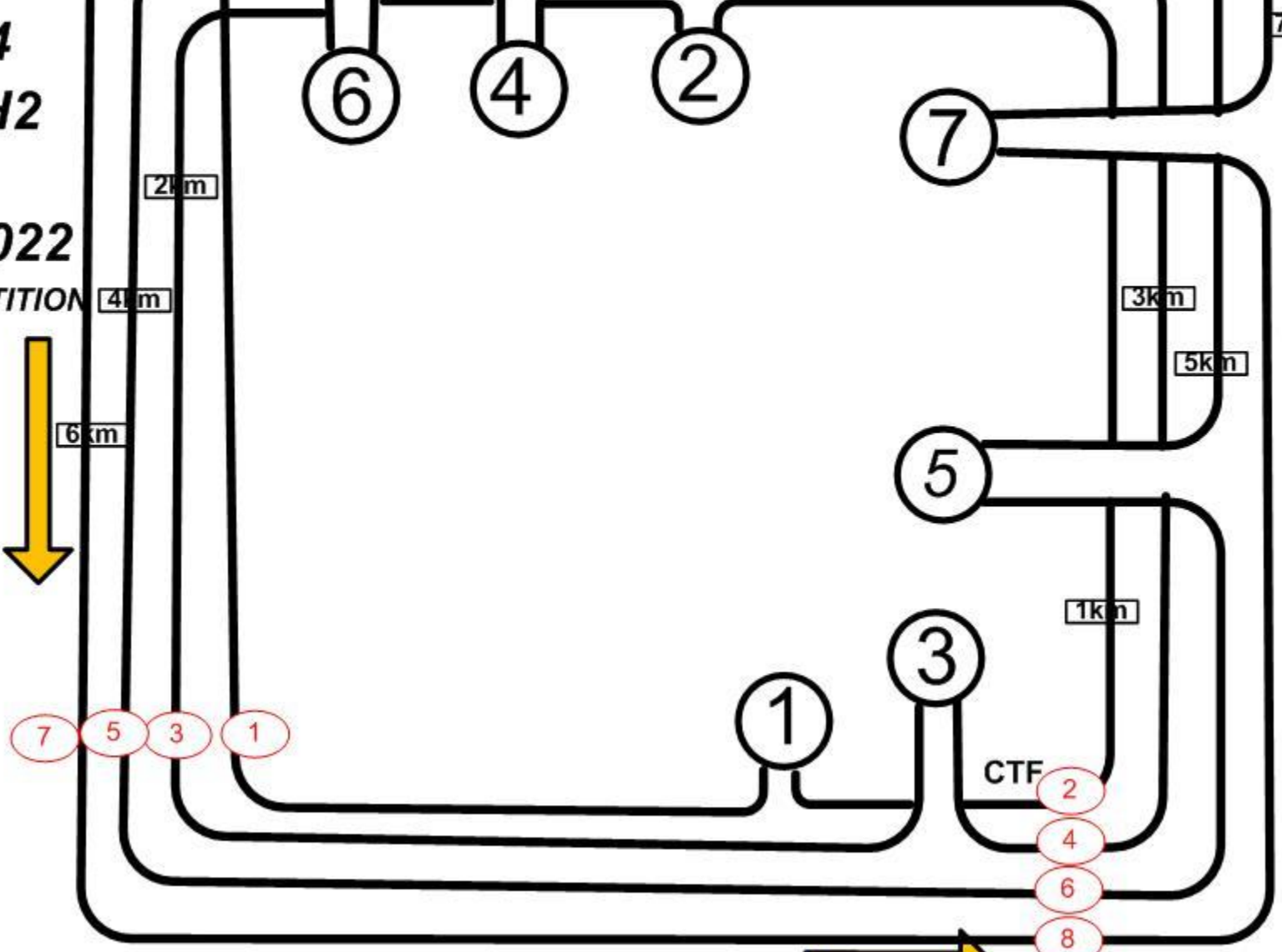
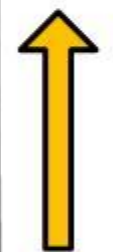

Finish
Start

CAI 3* H1-H2
VECSÉS 2022
MARATON COMPETITION
PHASE B

7330 m

CTF

CTF

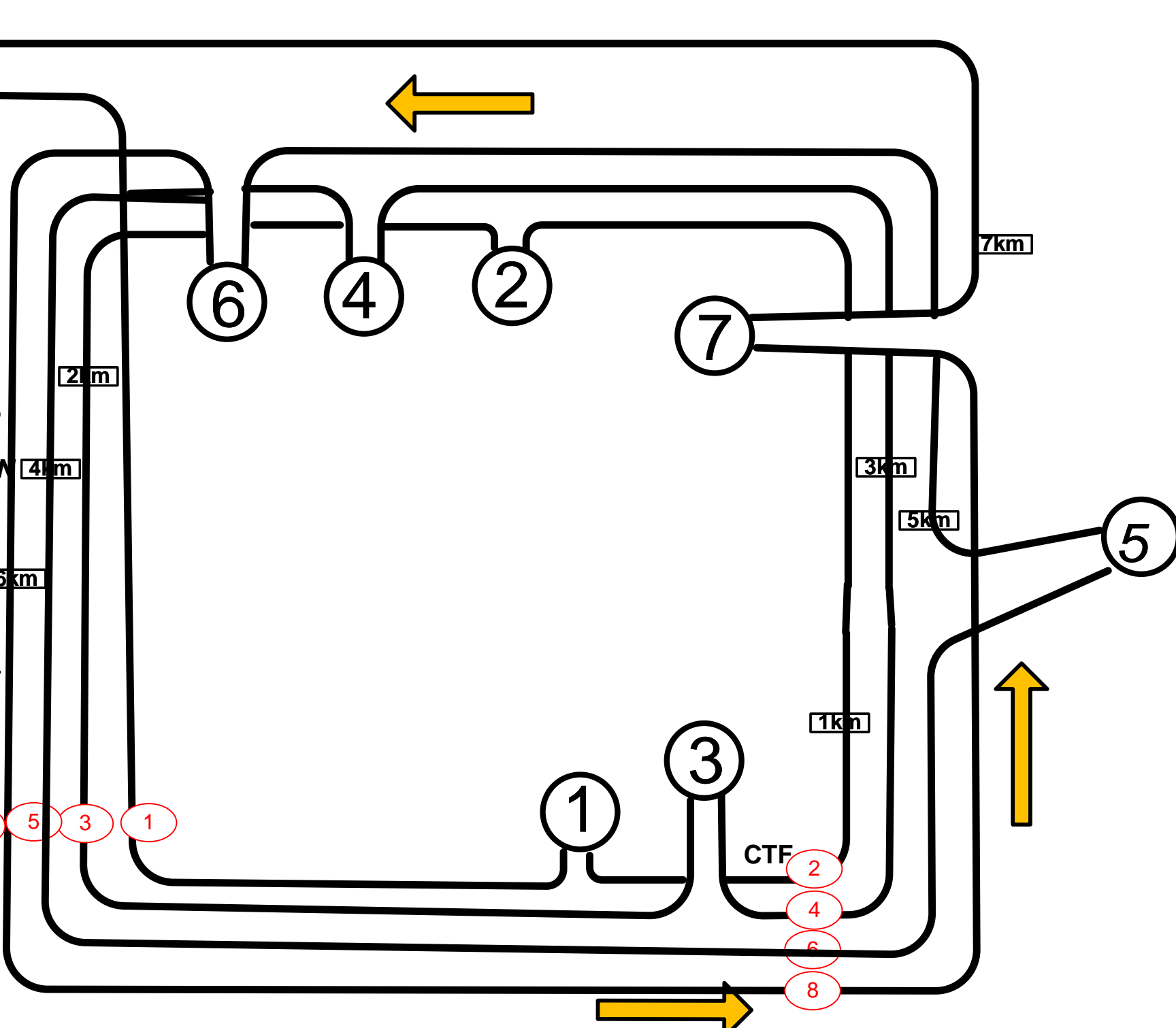

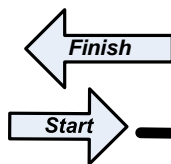

CAI 2*-CAN B -Junior -
U 25 - Para

VECSÉS 2022
MARATON COMPETITION
PHASE B

6690 m

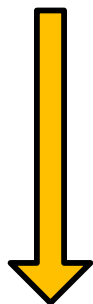

CTF



2km

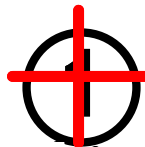

CTF



4km



5km



3km

1km



6km

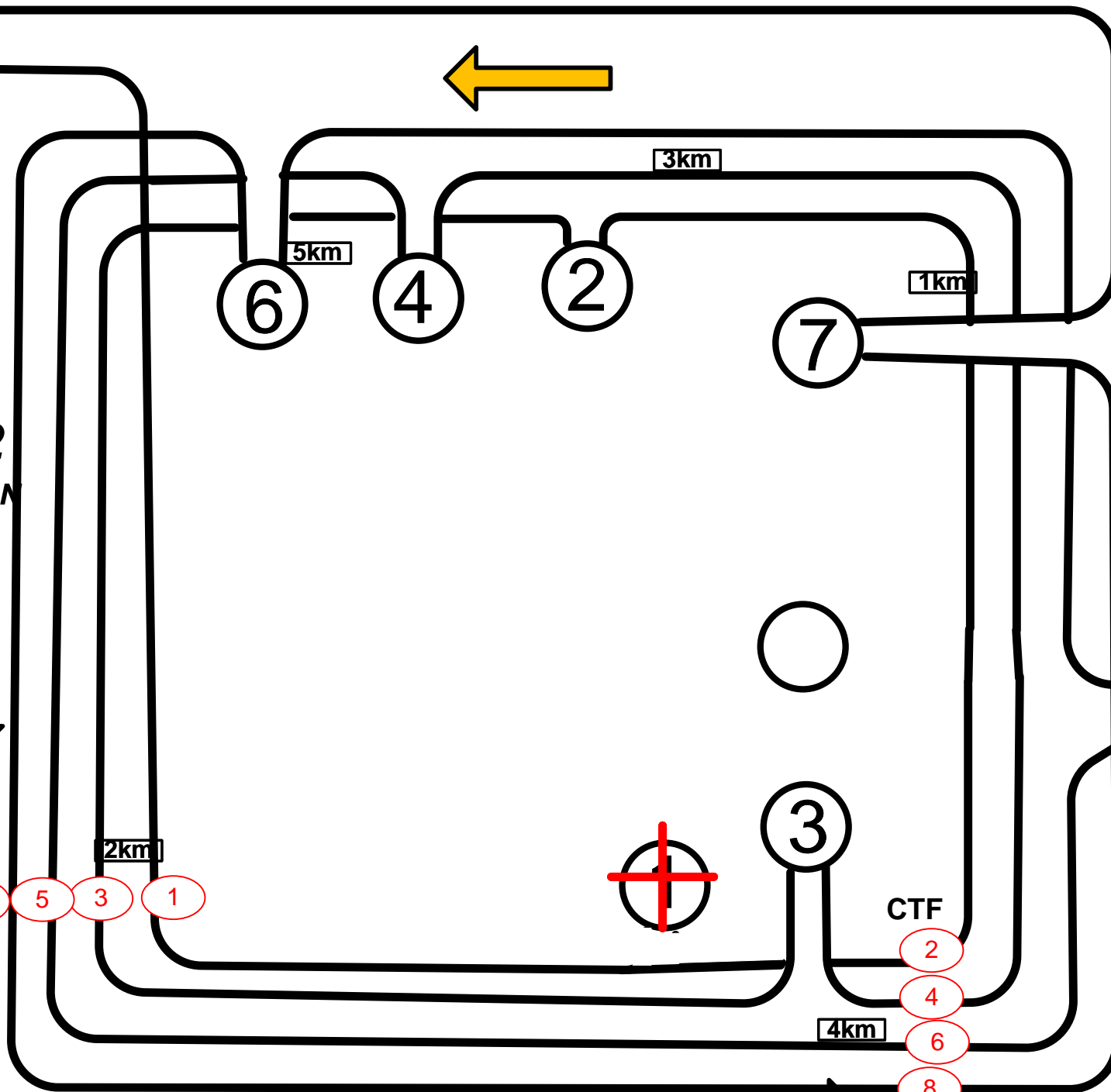
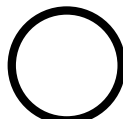

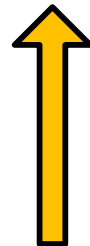
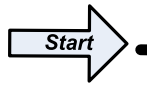

Gyermek

VECSÉS 2022

**MARATON COMPETITION
PHASE B**

4990 m

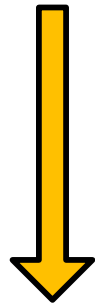

CTF



CTF



2km

3km

1km

4km

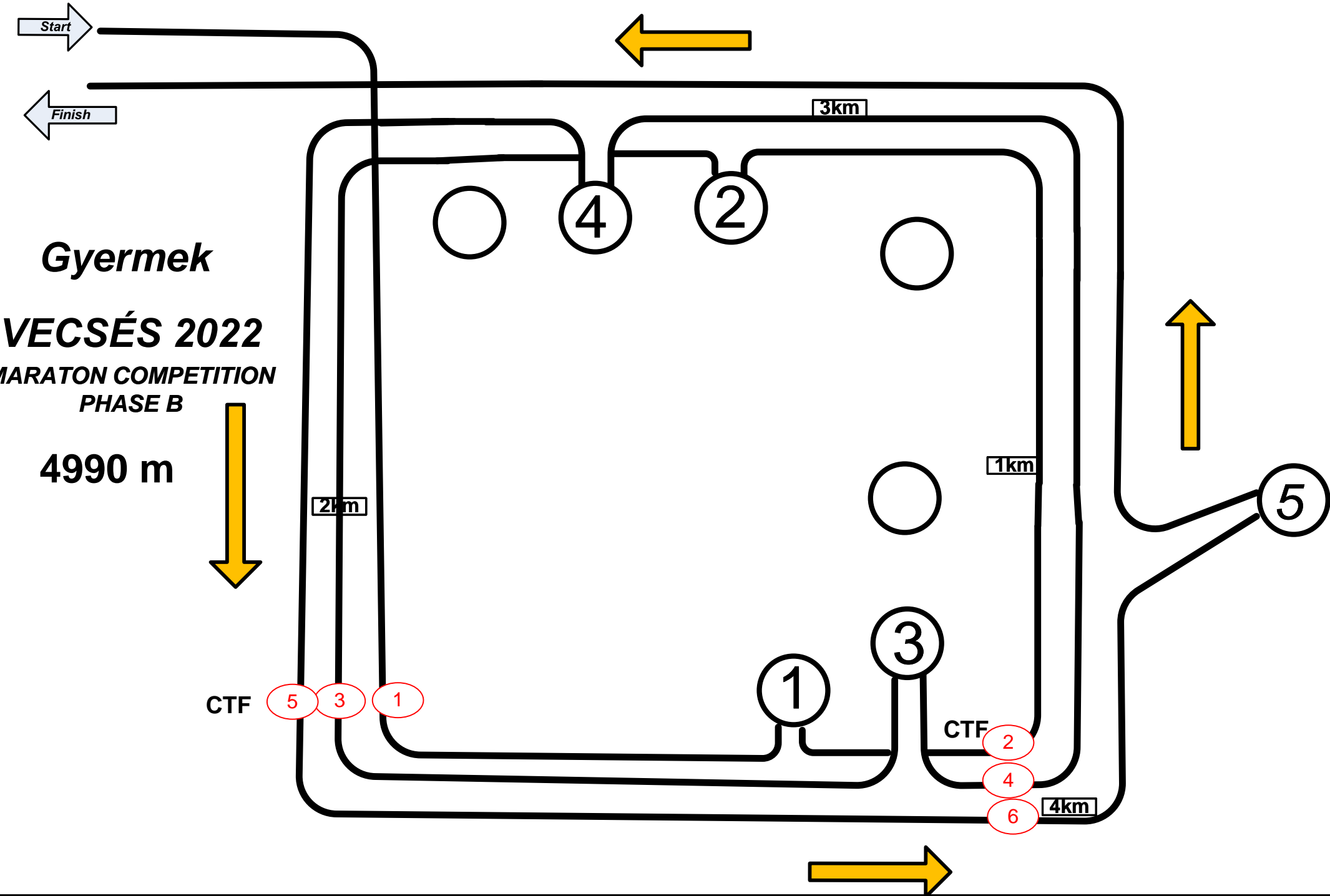
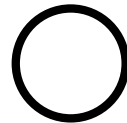
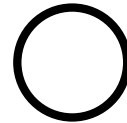
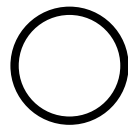

Vecsés 2022

CAI 3* H1- H2

B START

CTF 1

Obstacle 5

Obstacle 1

5 Km

CTF 2

Obstacle 6

1 Km

6 Km

Obstacle 2

CTF 7

2 Km

CTF 8

CTF 3

Obstacle 7

Obstacle 3

7 Km

CTF 4

3 Km

B FINISH

Obstacle 4

4 Km

7330 m

CTF 5

CTF 6

Vecsés 2022

CAI*** H4 – CAN A H2

B START

CTF 1

Obstacle 1

CTF 2

1 Km

Obstacle 2

2 Km

CTF 3

Obstacle 3

CTF 4

3 Km

Obstacle 4

4 Km

CTF 5

CTF 6

Obstacle 5

5 Km

Obstacle 6

6 Km

CTF 7

CTF 8

Obstacle 7

7 Km

B FINISH

7330 m

Vecsés 2022

CAI 2-CAN B -Junior – U 25 – Para*

START B

CTF 1

Obstacle 5

CTF 2

Obstacle 6 5 Km

1 Km

CTF 7

Obstacle 2

2 Km

CTF 8

CTF 3

6 Km

Obstacle 3

Obstacle 7

CTF 4

FINISH B

3 Km

6690 m

Obstacle 4

CTF 5

4 Km

CTF 6

Vecsés 2022

Gyermek

B START

CTF 1

Obstacle 1

CTF 2

1 Km

Obstacle 2

2 Km

CTF 3

Obstacle 3

CTF 4

3 Km

Obstacle 4

CTF 5

CTF 6

4 Km

Obstacle 5

B FINISH

4990 m

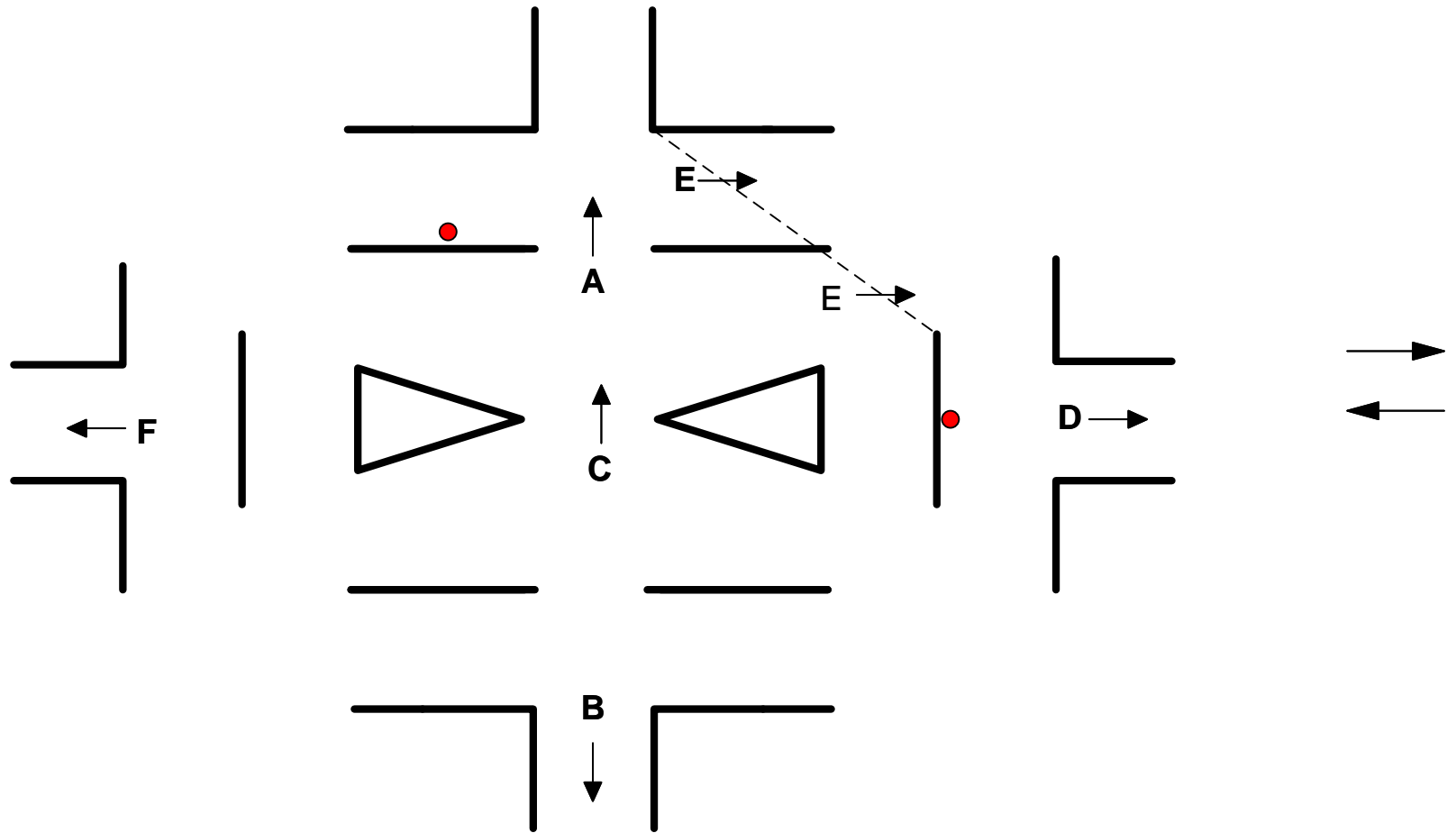

Vecsés 2022

2

CAI 3*-CAN A- A-B-C-D-E-F
CAI 2*-CAN B -Junior – U 25 – Para A-B-C-D-E

Gyermek A-B-C-D

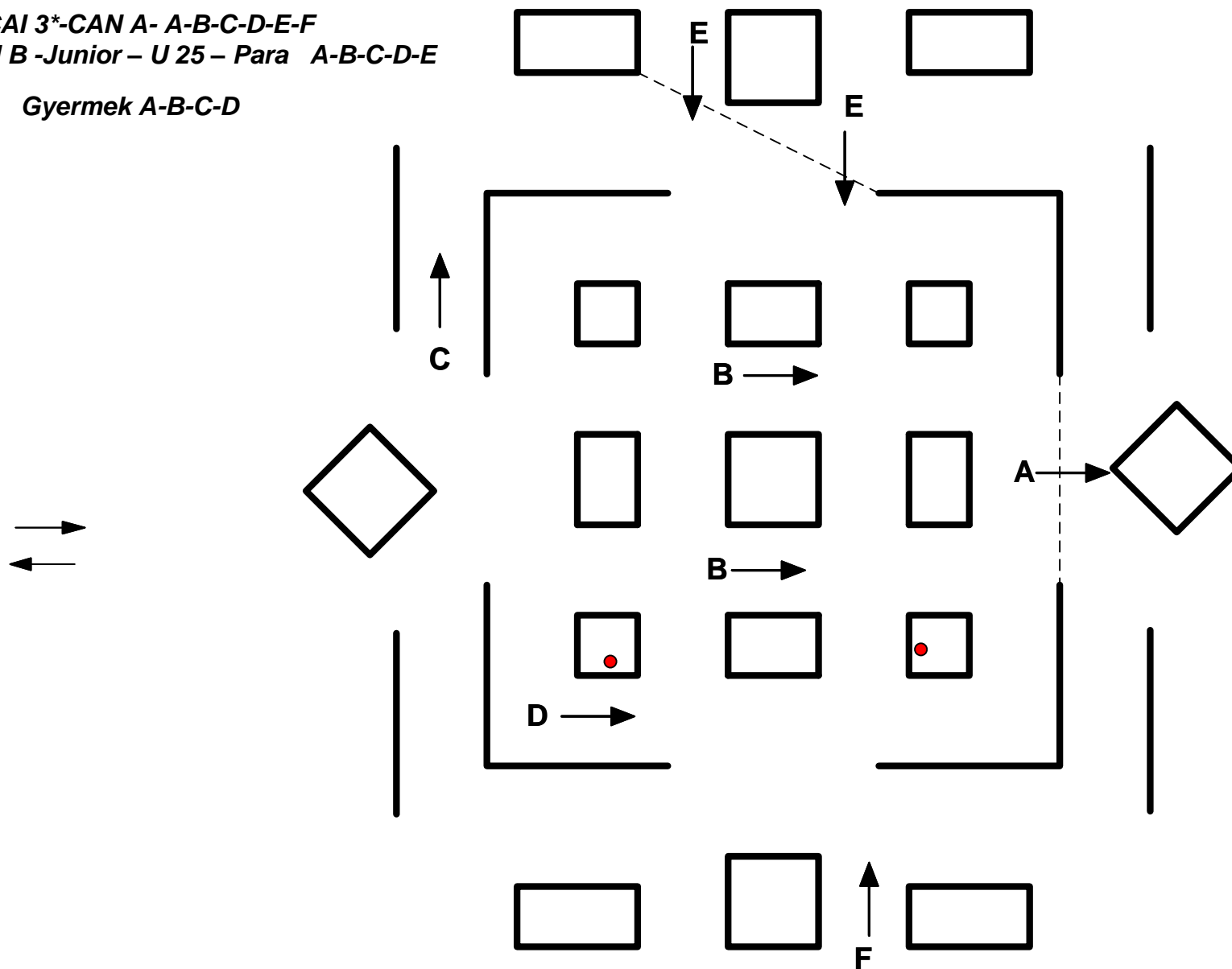

Knock down 2

Gyermek A-B-C-D

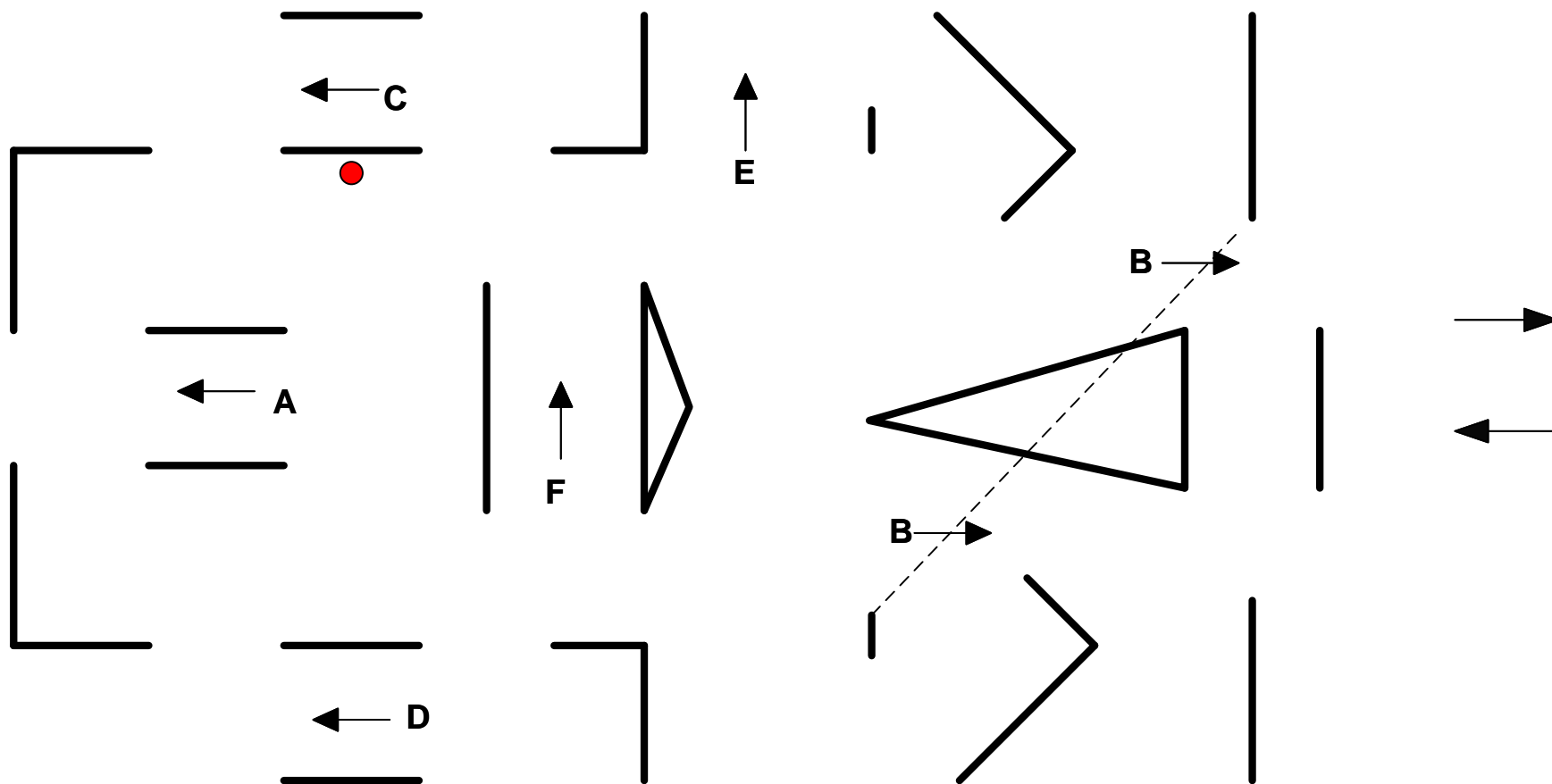

Knock down 1

Vecsés 2022

4

CAI 3*-CAN A- A-B-C-D-E-F
CAI 2*-CAN B -Junior – U 25 – Para A-B-C-D-E
Gyermek A-B-C-D

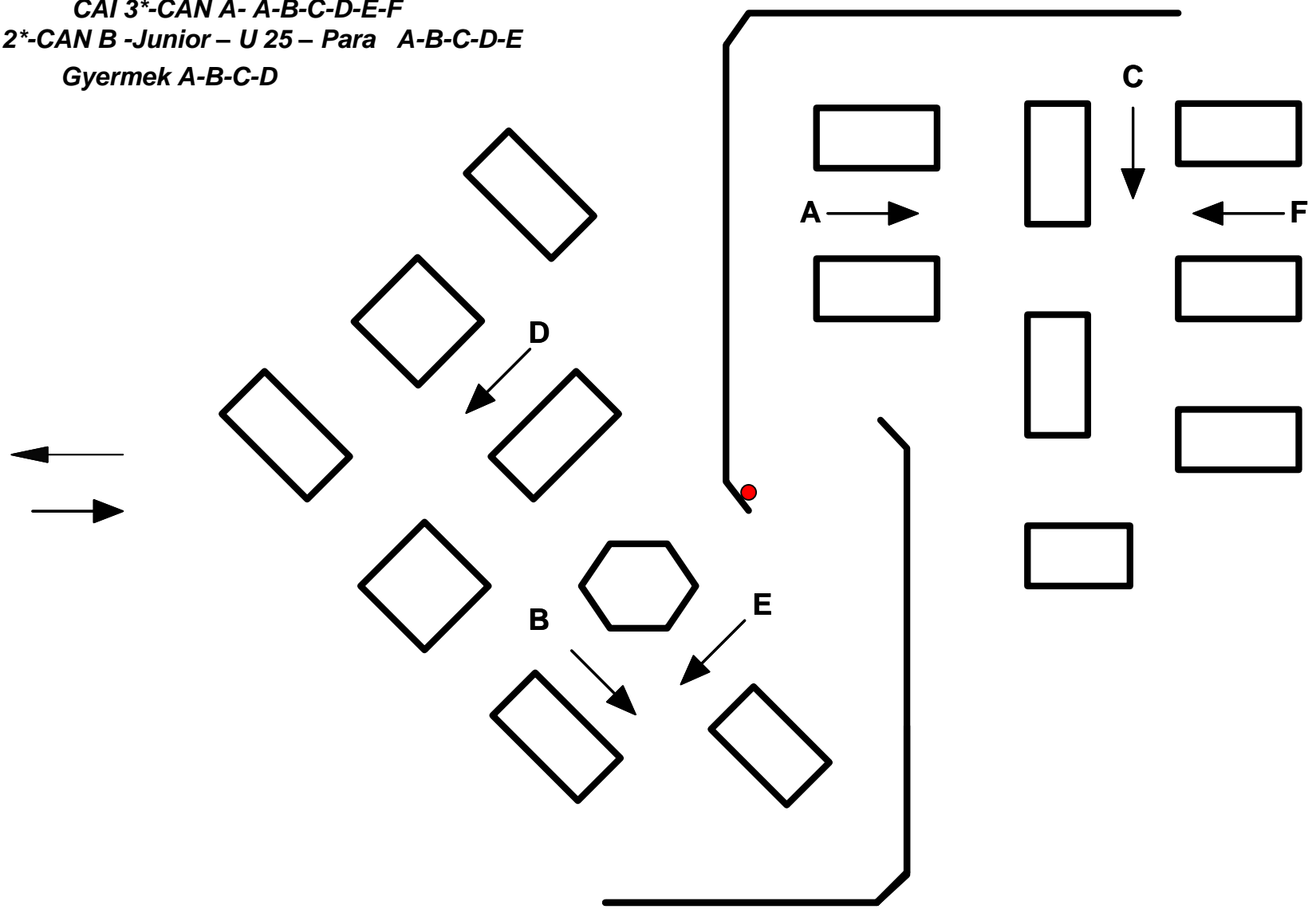

Knock down 1

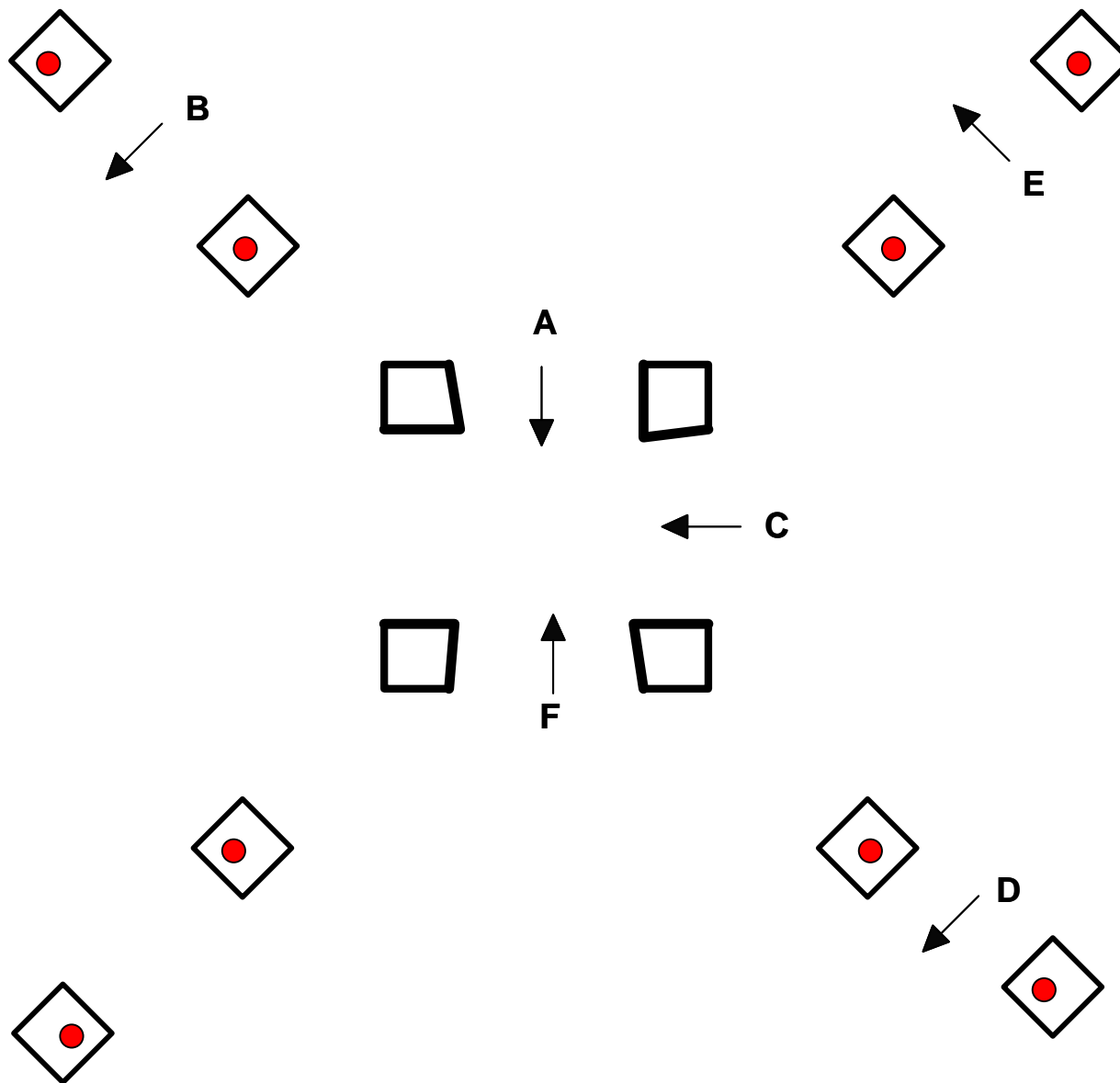

Knock down 8

